

Catalogue 2010



Tel.: 02 21 - 73 11 50
Fax: 02 21 - 820 73 73

A.F.Z.

B. Abels • **Film-Zubehör** • Krefelder Straße 18 • 50670 Köln

A.F.Z.Köln im Internet: www.afzk.de

abels film zubehör köln



We manufacture
costume-made products
like tripods, all kinds of clamps
and optical straightening benches,
as well as all makings for
cinematic equipment.

With the best wishes for a good cooperation.

Tel.: 0049-221-731150
Fax: 0049-221-8207373

B. Abels ▪ **Film-Zubehör** ▪ Krefelder Straße 18 ▪ 50670 Köln

A.F.Z. on the internet: www.afzk.de

Contents

1	Lights and accessories	Page 4 - 21
2	Clapper boards	Page 22
3	Trollies	Page 23 - 30
4	Grip	Page 31 - 39
5	Camera accessories	Page 40 - 46
6	Electronic accessories	Page 47
7	Connecting pins	Page 48 - 49
8	Release handles, handle bars & plugs	Page 50 - 52

Made in Germany

All the lamps will be delivered without illuminants (burners).

All the prices are without obligation. Please give us a call to ask for the current daily prices.

All the prices are net prices! - *valid from February 2010* -
Prices and technics are subject to change!

The Original

The first Dinolight we built in 1989/90. These lamp was very simple constructed, but very solid processed.

In the last 20 years we introduced a lot of improvements.

In early years the whole lamps were manufactured in steel zinc coated and they had an small brake. The ring of the burner had four knurled nut, to put the burner outside.

Now we produce all lamps only in stainless steel, with a big brake and you can put a burner outside if you remove only one knurled nut.

All prices are basic without burner!

PAR 36 Lamps

Minibrutes with 6, 8 or 9 burners

All prices are valid for black lamps,
in silver each lamp -60,-Euro
with tripod-holder, switchable by pairs.
Weight: about 10 -12kg.

Minibrute 6er 3,9 Kw lamp for 6 burner
Minibrute 8er 5,2 Kw lamp for 8 Brenner
Minibrute 9er 5,2 Kw lamp for 8 Brenner
with tripod-holder, switchable by pairs.

Order number 3500 EUR 1432,-
Order number 3510 EUR 1543,-
Order number 3515 EUR 1653,-



Information:

All the frames for the lamps are made of stainless steel. As we are the inventors of these lightweight lamp-constructions, we guarantee an ideal weight and at the same time a maximised stability of our products.

Burner PAR 36 650 watts, 110 volts



PAR 36 Lampen

Minibrute 12er

7,8 Kw lamp for 12 burners
with tripod-holder, switchable by pairs.
Weight: about 12 kg

Minibrute 12er

Order number 3518 black Euro 1899,-
Order number 3518 silver Euro 1799,-



LIGHTS & ACCESSORIES

PAR 36 lamps

All the lamps will be delivered without illuminants (burners).

Burner PAR 36 650 watts, 120 volts

NEW!



Light bar - 3,9 kilowatts

3,9 kilowatts lamp for 6 burners,

with tripod-holder, switchable by pairs. Order number 3520 EUR 729,-

Standing- and on-floor-
operation possible!



Wendylight - 31,2 kilowatts lamp ges. gesch.

31,2 kilowatts lamp for 48 burners,
with tripod-holder, switchable by pairs.
Weight with burners: 50 kg.

Order number 3600 EUR 5384,-
Order number 36010 EUR 5184,-

Wendylight-Willi 68 burners

41,6 kilowatts lamp for 64 burners,
with tripod-holder, switchable by pairs.

Order number 3602 black
EUR 5934,-

Order number 3602 silver
EUR 5734,-



Wendylight 48 burners



LIGHTS & ACCESSORIES

PAR 36 lamps

Super-Brute

The successor of our well-known Dinolight.
You can extend it from 24 burners
up to 48 burners by easily sticking it together.
Afterwards you will have a quarter of a Wendylight.

Burner PAR 36 650 watts, 120 volts

Super-Brute, single

15,6 kilowatts lamp for 24 burners,
with tripod-holder, switchable by pairs.
Weight with burners: about 25 kg8
Connection: 1 X 32 ampere, red.



Ordernumber 3610 black EUR 2881,-
Ordernumber 3611 silver EUR 2781,-



Super-Brute, double

31,2 kilowatts lamp for 48 burners,
with tripod-holder, switchable by pairs.
Weight with burners: about 50 kilogrammes.
Connections: 2 X 32 ampere, red.

Ordernumber 3615 black EUR 5730,-
Ordernumber 3616 silver EUR 5530,-

Aircraft Landing Light, 250 - 600 watts, 28 volts

All the lamps will be delivered without illuminants (burners).

Level of connection with 16 x 250 watts burners: 4 kilowatts.

Level of connection with 16 x 600 watts burners: 9,6 kilowatts.

With tripod-holder.

Connections: 2 x 32 ampere, blue, 230 volts, 50 hertz.

Weight with burners: about 30 kg.



only Dimmer



- Detailed back view -

Order number 3650 black EUR 3291,-
Order number 3655 silver EUR 3083,-

100 mm Brake



- Detailed view of the brake -

Burners from 250 up to 600 watts,

28 volts

This lamp is characterised by its remarkable light:
The landing light of today's commercial aircrafts
creates an extreme, broad and bright light.

PAR 64 lamps



- Detailed view of the brake -

100 mm Brake



Maxibrute 6 kilowatts lamp

The small-sized brothers of the Dinolight.
6 kilowatts lamp for 6 burners at 1000 watts,
with tripod-holder, switchable individually.
Connection 1 x 32 ampere, 400 volts, 50 hertz
Weight with burners: about 18 kg.

Order number 3700 black EUR 2208,-

Order number 3705 silver EUR 2150,-



The small-sized brothers of the Dinolight.

Maxibrute 9 kilowatts lamp

9 kilowatts lamp for 9 burners at 1000 watts,
with tripod-holder, switchable individually.

Order number 3710 black EUR 2695,-

Order number 3715 black EUR 2575,-

PAR 64 Lampen

Maxibrute 12 KW

12 Kw lamp for 12 burner á 1000 Watt
with tripod-holder, single switchable
Connection 1x 32 Amp. 400 V 50 Hz
Weight with burner about: 25 kg

Ordernumber 3712 black Euro 3274,-
Ordernumber 3713 silver Euro 3074,-



PAR 64 lamps

Dinolight 12 kilowatts lamp

12 kilowatts lamp for 12 burners at 1000 watts, with tripod-holder, switchable individually. Connection: 1 x 32 ampere, 400 volts, 50 hertz. Weight with burners: about 25 kg.

Order number 3800 black EUR 2898,-
Order number 3800 silver EUR 2748,-

Feature:
With 2 x 12 kilowatts and a T-connector you will get a unit with 24 kilowatts. When you order a second unit with 12 kilowatts, you will get the T-connector for free.



Just like all our lamps, the Dinolight consists of a robust construction of stainless steel and aluminium.

All the lamps will be delivered without illuminants (burners).
Brenner PAR 64 CP 60/61/62 500 bis 1000 Watt 230 Volt

Dinolight 16 kilowatts lamp

16 kilowatts lamp for 16 burners at 1000 watts, with tripod-holder, switchable individually. Connection: 2 x 32 ampere, 400 volts, 50 hertz.

Weight with burners: about 30 kg.
Order number 38001 black EUR 3548,-
Order number 38002 silver EUR 3348,-

More openly frameworks

Order number 38002 black EUR 3813,-
Order number 38002 silver EUR 3613,-



PAR 64 lamps

Dinolight 24 kilowatts lamp

Consists of 2 Dinolights and a connector.

24 kilowatts lamp for 24 burners at 1000 watts,
with tripod-holder, switchable individually.

Consists of 2 x 12 kilowatts Dinolights.

Connection: 2 x 32 ampere, 400 volts, 50 hertz.

Weight with burners: 50 kg.

Order number 380024 black EUR 5697,-

Order number 380024 silver EUR 5497,-

incl. T-connector

Spare part: T-connector

Order number 3854 EUR 107,-

Spare part: Connector for Dinolight NEW!

Order number 3861 EUR 8,25

Burner PAR 64 CP 60/61/62 from 500 up to 1000 watts,
230 volts

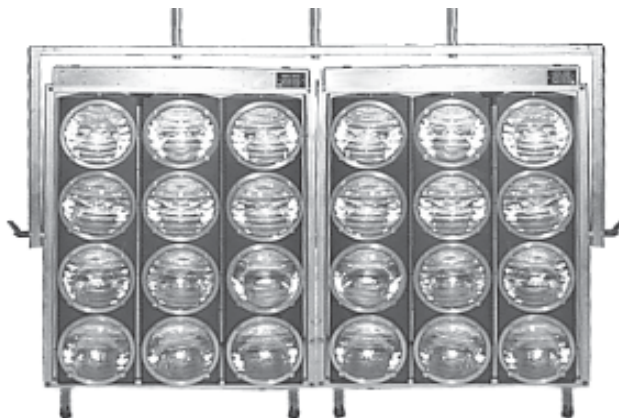

With handy transportation feet.

Rainshield for Dinolight 12 Kw & Maxi Brute 9 Kw

These rain-shield protect the burners against using rain and they are fast and simply together with the frameholder to be installed.

Ordernumber 3985 Euro 135,-



Dino Light 16 Kw



Brake disks for lamps (Dino Wendy Maxi Mini)

The brake disks for all lamps consists of extra durable materials, which should be renewed on a regular basis.

Brake disk 70 mm, 10 mm borehole.

Ordernumber 38044 EUR 3,80

Brake disk 100 mm, 10 mm borehole.

Ordernumber 38045 EUR 4,20

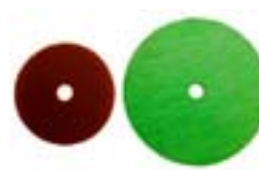

Foot for lamps Par 64 DX 16 D

DX 16 D

Made of porcelain for burners Par 64, with insulating screw joint.

Order number 3870 EUR 12,20

DX 16 D

Made of porcelain for burners Par 64, without insulating screw joint.

Ordernumber 3871 EUR 8,35



Red signal lamp with bulb, 230 volts

Signal lamp, red, for Dinolight, Maxibrutes, Wendylight, Minibrutes as a signalling for voltage.

Ordernumber 3875b EUR 10,42

Additional brake for lamps

Additional brake for all lamps. Doubles the brakeload.

Ordernumber 38041 EUR 73,50

Knurled nut made of stainless steel

Knurled nut for all lamps M 4.

Ordernumber 3862 EUR 2,-





Holder for frames for foil, made of stainless steel, for Dinolight, Maxi, Mini, Wendylight

With these holders you attach frames for foil on the lamps.
You will need 4 holders for each lamp.

Cost per piece

for Minibrutes with 6, 8 or 9 burners	Ordernumber 3900	EUR	74,50
for Wendylight	Ordernumber 3905	EUR	74,50
for Maxibrutes 6 or 9 burners	Ordernumber 3910	EUR	74,50
for Dinolight	Ordernumber 3915	EUR	74,50

Frames for foil

Lightweight but robust construction of aluminium rectangular pipe and splinter-proof wooden slats.
You attach the foil with a stapler.



Minibrutes, 6 burners	Ordernumber 3950	EUR	91,-
Minibrutes, 9 burners	Ordernumber 3955	EUR	91,-
Wendylight	Ordernumber 3960	EUR	146,-
Maxibrutes, 9 burners	Ordernumber 3970	EUR	102,-
Dino, 12 burners	Ordernumber 3975	EUR	124,-
Dino, 24 burners	Ordernumber 3980	EUR	162,-

Diffusion-frames (frames for foil)

Lightweight but robust construction of aluminium rectangular pipe and splinter-proof wooden slats.

You attach the foil with a stapler.

28 mm or 16 mm

aluminium connecting pins, for the shooting with a tripod or gobo.



Tip: 1,2 m frames are as broad as the foil

500 x 750 mm with 2 x 16 mm connecting pin	Order number 3000 EUR	102,-
600 x 600 mm with 1 x 16 mm connecting pin	Order number 3005 EUR	92,-
1 x 1 m with 28 mm connecting pin	Order number 3010 EUR	96,-
1 x 1,2 m with 28 mm connecting pin	Order number 3015 EUR	107,-
1,2 x 1,2 m with 28 mm connecting pin	Order number 3020 EUR	124,-
1,5 x 1,5 m with 28 mm connecting pin	Order number 3025 EUR	151,-
1 x 2 m with 28 mm connecting pin	Order number 3030 EUR	151,-
1,2 x 2 m with 28 mm connecting pin	Order number 3035 EUR	162,-

- All the frames are also available without the wooden slats -

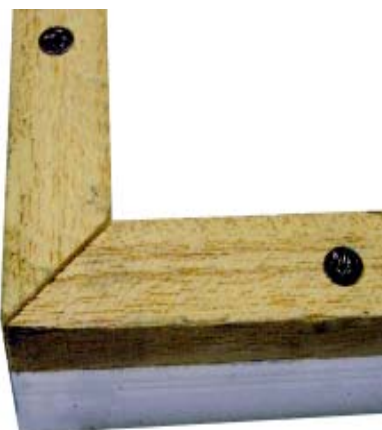

Shiny-board reflector-set

Lightweight but robust construction, made of aluminium. The reflectors can be changed independently. The holder is made of stainless steel. Relocatable steelplates allow a fast changing. The reflectors consists of 2 lightweight building boards and can be changed individually.



Detail



- Complete Shiny-board reflector-set** 0,5 x 0,5 m
with reflector foil, silver, matt and shiny Order number 3195.b EUR 458,-
- Complete Shiny-board reflector-set** , 1 x 1 m
with reflector foil, silver, matt and shiny Order number 3195 EUR 684,-
- Complete Shiny-board reflector-set** , 1,2 x 1,2 m
with reflector foil, silver, matt and shiny **Order number 3194 EUR 884,-**

NEW 1,2x1,2 m



- Complete Shiny-board reflector-set**, 0,5 x 0,5 m
with mirroring foil and matt foil Order number 3196.b EUR 493,-
- Complete Shiny-board reflector-set**, 1 x 1 m
with mirroring foil and matt foil Order number 3196 EUR 755,-

- | | | | |
|-------------------------------------|--|-----------------------|------|
| Reflector, silver, matt, 1 x 1 m | | Order number 3200 EUR | 95,- |
| Reflector, silver, shiny, 1 x 1 m | | Order number 3205 EUR | 92,- |
| Reflector, silver, shiny, 0,5 x 0,5 | | Order number 3206 EUR | 42,- |
| Reflector, gold, matt 1x 1 m | | Order number 3210 EUR | 96,- |
| Reflector, gold, shiny 1x 1 m | | Order number 3211 EUR | 93,- |

- | | | |
|---|-----------------------|-------|
| Reflector, mirroring , glass, 1 x 1 m | Order number 3215 EUR | 124,- |
| Reflector, mirroring , glass, 0,5 x 0,5 m | Order number 3216 EUR | 85,- |
| Reflector, mirroring , glass, 1 x 1 m,
without wood | Order number 3217 EUR | 79,- |
| Spare part: reflector, 1 x 1 m, without reflectors | Order number 3218 EUR | 473,- |
| Box for carriage, made of robust cardboard | Order number 3219 EUR | 16,15 |
| Box for carriage for 1 x 1 m blind | Order number 3220 EUR | |

Complete Shiny-board reflector-set , 1,2 x 1,2 m
with reflector foil, silver, matt and shiny **Order number 3194 EUR 884,-**



Order number 3195Euro 684,-



Wooden clapper boards, black

Clapper boards made of special wood, black-colour coated, white imprint. You can write on them with white chalk.



small, 200 x 150 millimetres
medium, 300 x 250 millimetres
large, 400 x 350 millimetres

Order number 5005 EUR 45,-
Order number 5010 EUR 50,-
Order number 5015 EUR 70,-

Order number 5107 EUR 80,-
Order number 5108 EUR 85,-



Back light clapper boards, plastic, white

Tranlucent clapper boards, made of plastic, black imprint. You can write on them with a marker, which can be wiped off when it's dry.



small, 180 x 180 millimetres
medium, 250 x 250 millimetres

Order number 5105 EUR 50,-
Order number 5110 EUR 53,-

Insert clapper board



Order number 5115 EUR 17,90

The building of trolleys with AFZ Köln

We built the trolley only in stainless steel and aluminium in single or small series, we have a long experience and we guarantee a long durability over many years.

KinoFlo trolley

This trolley is specially produced to transport "KinoFlo`s" in different sizes surely. With rainshield!

Ordernumber 2184

Euro 2100,-





Grip-trolley, made of aluminium

All-purpose grip-trolley.
Fits into lifts and all common doors.
To store GoBos, C-stands, tripods, stack-boxes etc.
The wheels are made of solid rubber.

Size: 70 cm broad, 190 cm high, 130 cm long.

Order number 2165 EUR 3184,-

Grip-trolley, **small**, for Mercedes Sprinter and likewise transportation vehicles

Order number 2166 EUR 3130,-

The construction of the trolley is like the trolley with the order number 2165 but the height of this one is a little bit smaller, so you can also put it into smaller vehicles. Size: 70 cm broad, 180 cm high, 130 cm long.

Stack-boxes (Euro boxes) for grip-trolleys

Euro boxes, 40 cm broad, 60 cm long - available on request -

fresnel-trolley

Tough trolley made of stainless steel, with brake for fresnels 16 x 1 Kw or 12 x 2 Kw. Also mixable.



Ordernumber 2168

Euro 1179,-

Transport-trolley for cranes, made of stainless steel

Transport-trolley for the storage of a complete crane arrangement,
for example the "Phönix"-crane.
Robust air tyre equipment!

Ordernumber 2170 EUR 1789,-

- without illustration -

Transport-trolley for tripods

Trolley made of stainless steel, for the
transport of tripods of variable sizes
in one division.



Solid rubber tyre equipment

Ordernumber 2175 EUR 1294,-



Transport-trolley (Cable-trolley)

Made of stainless steel and aluminum.
Robust air tyre equipment!
With 2 brakes.

Ordernumber 2180 EUR 1402,-

Trolley for tripods, made of stainless steel

This small trolley is perfect for the transport of many different tripods.

You can use this small but well-engineered trolley both in halls and outdoors. The trolley has space for a lot of different tripods and ensures fast working on the set.



Small trolley for tripods

Stainless steel and aluminium.

Order number 2176 EUR 1294,-

Size: 600 mm broad and 830 mm long.



Solid rubber tyre equipment, brake in the front.



TROLLIES

Cars manufacture special production of car we according to your data.

Picture magliner special production

with euro adapter and pneumatic.

Order number 22050 EUR 2449-



Transport trolley for trackage

Stainless steel, tyre equipment at buyer's option.

Order number 2185 EUR 1387,-



Magliner

Original Magliner by the company MAGLINER. Without shelves.

Ordernumber 2200 EUR 745,-

Magliner, complete

All the steelplates are made of aluminium, without coating. With 2 aluminium-shelves and front holder for a maximum of 2 tripods in the container.

Order number 2205 EUR 1531-



Shelves

All the steelplates are made of aluminium, without coating.

Set of steelplates, (top, bottom and front)	Ordernumber 2206	EUR 662,-
Bottom steelplate	Ordernumber 2207	EUR 192,-
Top steelplate with 2 clamps	Ordernumber 2208	EUR 248,-
Shelf for tripod	Ordernumber 2209	EUR 248,-

Multifunctional transport trolley for tripods

700 mmlong, 500 mm broad, 1500 mm high.

Multifunctional transport trolley for tripods and sandbags or with shelves for the transport of plastic boxes. All the shelves are universally adjustable. With 2 shelves and separating plate.

Order number 2178 EUR 859,-





Aluminium-adaptors

with current price reductions!

16 mm connecting pin on 28 mm sleeve	Order number 1000	EUR 68,50
28 mm connecting pin on 16 mm sleeve	Order number 1005	EUR 57,70
28 mm connecting pin on 28 mm sleeve	Order number 1010	EUR 57,80
28 mm sleeve on 28 mm sleeve	Order number 1020	EUR 41,55
16 mm sleeve on 28 mm sleeve	Order number 1025	EUR 79,-

Set for the extension of tripods "Onko-Bonko"

Extension for tripods 300 mm, 400 mm, 500 mm
 Pipe made of stainless steel with connecting pin made of aluminum 28 mm
 Order number 1040 EUR 139,-



Sucker
 Dual-sucker made of aluminium
 for the fixing on all even surfaces
 like glass, marble and on cars.
 Fixing by clamping of the levers.

16 mm retainer sleeve		
Size: 320 mm long, 130 mm high, 120 mm broad.	Order number 1065	EUR 102
Without retainer sleeve	Order number 1070	EUR 75,-
Sucker, large, 16 mm connecting pin	Order number 1075	EUR 57,-
Sucker, large 16 mm connecting pin, flexible	Order number 1076	EUR 78,-





Clamping equipment

Item number
1086.b

Equipment for clamping lights between walls.

Order number 1085 cost per piece EUR 275,-

Holder for clamping

Clamping ring for extraxtion tubes Order number 1085.1 cost per piece EUR 69,50

Item number
1086.a



Set: 2 clamping equipments, with tubes and bags. Order number 1086.a EUR 1127,-

Set: 2 clamping equipments, with clamping ring and bag. Order 1086.b EUR 696,-

Set of 5 tubes for clamping equipment, with bag. Order number 1087 EUR 665,-

All the parts are seperately available as well!

Item number 1087



Wallspreader Set

We build this Wallspreader since 1992

2 Wallsprader-Set in the Cases completely with 2 clamps and doble clamp
2 Adapter pipes 45/50 mm

2er Set without pipes Ordernumber. 1088 EUR 1657,-

Cases Set

Cases Contents

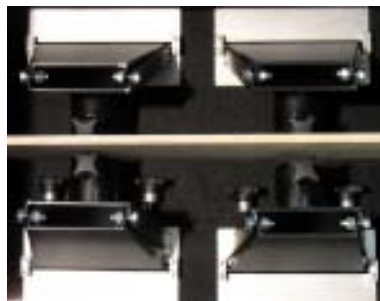

Set of 5 tubes for clamping equipment, with bag. Ordernumber 1087 EUR665,-



NEW

Foreman-tripod completely with lamp-holder for 28 mm taps
The adjustable legs adapt themselves to each foreman and become with
Instep-belts at the foreman fortified

Order number 1121 Euro 1350,- length 2500 mm 3 Lamps holders

Order number 11210 Euro 999,- length 2000 mm 1 Lamps holders



Holder for pipes „Big Ben“

Clamp for
Mannesmann-tube 48 mm.
With 28 mm connecting pin



Order number 1125 EUR 23,50

Application:

*With this item you can clamp 48 mm Mannesmann-tubes, for example to construct a bridge out of 2 tripods with a clamp on each of them.
With the clamping system you can put 2 or more clamps - depending on the weight - on a ceiling extension. In his way you can hang a tube along the ceiling.*

Styro-holder

Styro-holder, adjustable from 25-50 mm,
all-aluminium & 28 mm aluminium connecting pin.
Holder for skewer,
made of stainless steel only,
with 16 mm tube or connecting pin.



Order number 1130 EUR 71,00

Order number 1135 EUR 36,00

Deposition for tripods

Deposition for
putting items onto the tripod.



Deposition for tripods small 150 mm
Deposition for tripods medium 250 mm
Deposition for tripods large 350 mm

Order number 1140 EUR 33,00
Order number 1145 EUR 38,00
Order number 1150 EUR 48,00

On-floor folding tripod made of stainless steel

Light tripod made of square pipe,
fold-away into every position,
without snapping in.



For all spotlights with 28 mm connecting pins. Order number 1170 EUR 98,-

Holder for frames for foil

To provide frames for foil with a connecting pin.
Made of stainless steel.

with 16 mm connecting pin
with 28 mm connecting pin

Order number 3125 EUR 74,-
Order number 3126 EUR 95,-



Column tripod

You brace the extension with belts,

with 28 mm absorption.
The item will be delivered without belts!

Length 300 mm

Order number 1210 EUR 53,69



Extension arm (Droparm)

28 mm connecting pin with 28 mm sleeve,
size: length 300 mm
Telescopic extension arm
Telescopic extension arm, 700-1200 mm
Grip helper, telescopic by 45 degrees,

Order number 1200 EUR 46,-
Order number 1215 EUR 145,-
Order number 1220 EUR 159,-
Order number 1220 EUR 203,-

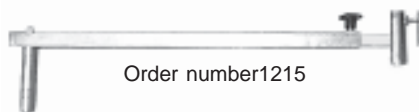

Order number 1215



ges. gesch.

Bender made of stainless steel

All-purpose hinge for stageless bending,
28 mm connecting pin, 28 mm sleeve.

Length 370 mm

Order number 1230 EUR 98,-

Small bender, 16 mm connecting pin, 16 mm sleeve Order number 1235 EUR 85,-

Application:

All-purpose hinge-holder, which brings for example frames for foil, sunshades or flags into the right position to the lamp. This item has a great holding force: the brake force in the hinge is about 80 kg.



Special bender made of stainless steel

Very robust construction - all-purpose. Available on request.

Special bender for microphone-rods

Order number 1240 EUR 213,-

On-floor holders (Baby Plates)



16 mm sleeve	Order number 1250 EUR	12,76
16 mm connecting pin, stainless steel	Order number 1255 EUR	16,50
28 mm connecting pin	Order number 1260 EUR	24,57
28 mm sleeve, stainless steel	Order number 1265 EUR	32,50

Praktikabel

1 meter x 1 meter
 high 25 cm Order number 1299 EUR 415
 high 50 cm Order number 1300 EUR 440
 high 100 cm Order number 1305 EUR 465

1,5x1,5 Meter
 high 25 cm Order number 1309 EUR 505
 high 50 cm Order number 1310 EUR 538
 high 100 cm Order number 1310 EUR 554



Stapelsegmente

1x1 meter Order number 1326 EUR 150
 1,5x1,5 meter Order number 1327 EUR 185



Praktikabel" boards

Multiplex wooden board 18 mm thick, with hole for carrying.
 25 mm wooden boards are available on request!

100 cm long, 100 cm broad	Order number 1330 EUR	119,-
150 cm long, 150 cm broad	Order number 1335 EUR	165,-
100 cm long, 200 cm broad	Order number 1340 EUR	185,-



Safety ropes "Safety"

Trapping rope, made of 2 mm steel rope, length 80 cm,
up to 10 kp trapping weight, with shackle Order number 1350 EUR

Trapping rope, made of 5 mm steel rope, length 100 cm,
up to 80 kp trapping weight, with shackle Order number 1354 EUR 14,30
Every rope will be delivered with a shackle or a screw link.

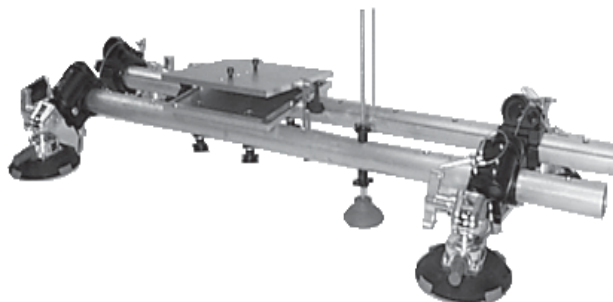

Carmount

all-purpose auto tripod Order number 1400 EUR 1904,-
Basic version can be optionally extended by your own wishes.

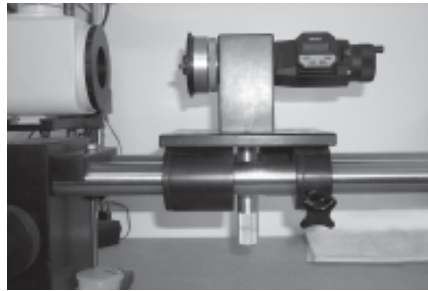
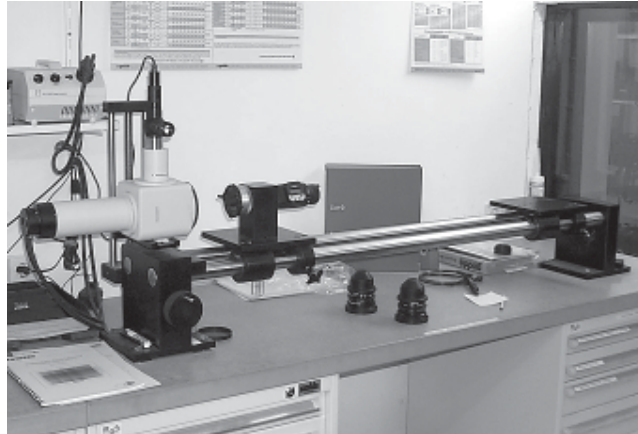

We manufacture for you:

Collimators (optical straightening benches)
specially designed according to
your wishes.

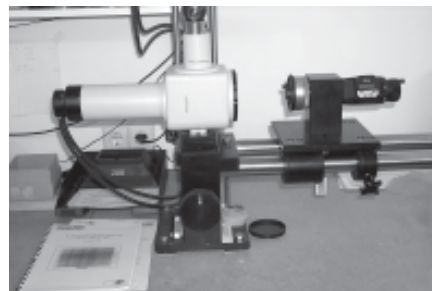



Pipe-extensions

Consisting of a large absorption made of steel (*Elemack connecting pin*), a clamping arrangement made of steel and a connecting pipe made of aluminium.
Robust but lightweight construction!



Length 100 mm	Order number 4000 EUR	342,-
Length 150 mm	Order number 4005 EUR	353,-
Length 250 mm	Order number 4010 EUR	364,-
Length 350 mm	Order number 4015 EUR	375,-
Length 450 mm	Order number 4020 EUR	386,-

Extensions in other lengths are available on request!

Adjustable pipe-extension

about 50 mm



Order number 4025 EUR 690,-

Set of pipe-extensions with tripod

Consisting of 4 Bazookas, 1 screw-Bazooka, 1 tripod. Order number 4500 EUR 2567,-
Application:

You use pipe-extension primarily as an extension for tripods, for example for Dolly-handling or as hook-in-tripods for cars and car windows. Applicable for almost any kind of handling, with which you use jackets or jackets for the absorption of balls (tulips).



Plate for adjusting cameras "Low-Shot" *New shape!*

With diverse boreholes
and 3/8"-screw threads

Application:

With this item you bring the camera into every position you want. You can fix every position by the use of the distributed boreholes and screw threads.

Order number 4055 EUR 220,-



3/8" screws

Length 16 mm

Order number 4060 EUR 4,70



On-floor camera tripod with Euro-absorption

Lightweight but robust tripod made of steel. Order number 4100 EUR 720,-

Small on-floor star

Consisting of a large absorption (80 mm Euro) made of aluminium and a steelplate with 3 set-screws for adjusting the plate. Robust but lightweight construction.

Size: diameter 500 mm

Order number 4105 EUR 328,-



Large on-floor star

Consisting of a large absorption (80 mm Euro) mad of aluminium and a steelplate with 3 set-screws for adjusting the plate. Robust, larger construction.

Size: diameter 700 mm

Order number 4110 EUR 356,-



Evasion pieces

Clip evasion pieces for Sony 400 and other cameras identical in construction.

Order number 4180 - Price on request -

Application:
You use this item when using a compendium for not damaging the clip on the objective.



Zoom-levers

Zoom-levers in diverse lengths and with different screw threads.

Order number 4180 jeEUR 52,-



Turning levers



Order number 4185 EUR 245,-
Order number 4186 EUR 212,-

Compendium-bars

in all possible lengths and diameters are available on request...



Order number 4350



Order number 4361

Euro connecting pins

aluminium	Order number 4350 EUR	90,-
stainless steel only as a special design	Order number 4355 EUR	199,-
Euro-Alu with Mannesmann-clamp	Order number 4360 EUR	149,-
Euro-Alu with 28 mm connecting pin	Order number 4361 EUR	145,-
Euro-Alu with 28 mm sleeve	Order number 4362 EUR	178,-
Euro-absorption made of steel, 80 mm	Order number 4363 EUR	116,-
Euro-absorption made of steel, 80 mm with 28 mm sleeve	Order number 4364 EUR	210,-
Euro connecting pin alu-ladder-tripod	Order number 4365 EUR	199,-



Order number 4360



Order number 4365



Holder for Motorzoom

Made of aluminium,
for 15 or 19 mm compendium-tubes.

Order number 4400 EUR 357,90

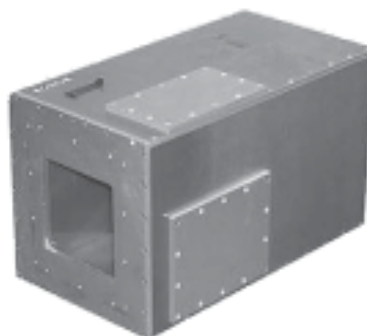

Crash-Box

Made of aluminium for ARRI SR1, 2 or 3,
accessible from the top and from the rear,
with with holder eyes.

Individual fixing according to your wishes!

Order number 4550 EUR 2346,-

wind engine 7000 qbm

Ordernumber 6050 Euro 1345,-

metrics 630x630x330mm 3 x switchable 230 Volt 1400 rpm

pins 28/16



special accessoris : flexible tube

Ordernumber 6055 Euro 495,-



CONNECTING PINS



DIN-connecting pins

Aluminium, 28 mm with internal screw thread **M10** Ordernu. 7000AL EUR 10,75
Stainless steel, 28 mm with int. screw thread **M10** Ordernu. 7000VA EUR 12,75

Aluminium, 28 mm with internal screw thread **M12** Ordernu. 7005AL EUR 11,75
Stainless steel, 28 mm with int. screw thread **M12 VA** Order no. 7005 EUR 14,30

Stainless steel with flange, 28 mm with internal screw thread **M10**
 Ordernumber 7010 EUR 22

Stainless steel with flange, 28 mm with internal screw thread **M12**
 Ordernumber 7011 EUR 23

DIN-connecting pins, aluminium with large absorption



Internal screw thread **M10**, with large flange Ordernumber 7015 EUR 16,75
 Internal screw thread **M12**, with large flange Ordernumber 7016 EUR 17,75

Double connecting pin 28/28

28 mm connecting pin on 28 mm connecting pin Ordernumber 7100 EUR 28,-



TV-adaptor-connecting pins

Adaptor TV large on small 28/16 mm Ordernumber 7105AL EUR 13,50
 Adaptor TV large on small 28/16 mm Ordernumber 7105VA EUR 19,50



Aluminium connecting pin

16 mm 100 mm length Ordernumber 7115 EUR 4,86



Aluminium connecting pin

16 mm short M8 internal screw thread



Order number 7120 EUR 5,40

Aluminium connecting pin

16 mm short M10 internal screw thread



Order number 7125 EUR 5,65

Aluminium connecting pin

16 mm long M8 internal screw thread



Order number 7130 EUR 7,85

Aluminium connecting pin

16 mm long M10 internal screw thread



Order number 7135 EUR 7,95

Aluminium connecting pin, discharged

16 mm long M10 internal screw thread

Order number 7140 EUR 9,75



Brass connecting pin, small

16 mm with M10-screw thread
16 mm with M10-screw thread 40 mm
16 mm with 3/8 or 1/4 screw thread



Order number 7200 EUR 9,25
Order number 7200a EUR 14,45
Order number 7201 EUR 15,45

Brass connecting pin, large

16 mm 100 mm long



Order number 7205 EUR 7,40

Clamp lever & Star handles



clamp lever black

with inside thread

M5	plastic	Ordernumber 8005	Euro	6,86
M6	plastic	Ordernumber 8010	Euro	6,86
M8	plastic	Ordernumber 8015	Euro	6,86
M10	plastic	Ordernumber 8020	Euro	7,94
M10	steel coated	Ordernumber 8021	Euro	13,50
M10	stainless steel	Ordernumber 8022	Euro	17,23
M12	stainless steel	Ordernumber 8023	Euro	17,87

with outside thread

M6 x 16	plastic	Ordernumber 8050	Euro	7,18
M8 x 16		Ordernumber 8055	Euro	7,18
M8 x 30		Ordernumber 8060	Euro	7,40
M10 x 16		Ordernumber 8065	Euro	7,40
M10 x 30		Ordernumber 8070	Euro	7,51
M12 x 40		Ordernumber 8075	Euro	8,05



Star handles plastic

with inside thread

M8	Ordernumber 8200	Euro	2,89
M10	Ordernumber 8205	Euro	3,63
M12	Ordernumber 8210	Euro	5,68

with outside thread available on request





knurled nut in stainless steel

knurled nut M 4
for whole lamps

Ordernumber 3862 Euro



male union for trust piece

M 8 x 60
M10 x 60
M10 x 80

Ordernumber
Ordernumber
Ordernumber



trust piece (steel)

M 8
M 10

Ordernumber
Ordernumber



T-handles (with inside & outside thread)

M 10
M 12

Ordernumber
Ordernumber



Plugs and caps made of plastics



Plugs in black

Plug 60mm x 60mm	Ordernumber	8500	EUR	2,65
Plug 30mm x 30mm	Ordernumber	8502	EUR	1,67
Plug 25mm x 25mm	Ordernumber	8504	EUR	1,57
Plug 25mm x 50mm	Ordernumber	8510	EUR	2,-

Round plug

Round plug 22 mm	Order number	8550	EUR	1,46
------------------	--------------	------	-----	------



Caps

Round cap 30 mm	black
Ordernumber	8560 EUR 1,24

Brake discs

Brake discs for lamps, mad of extra-durable materials.

Brake disc, 70 mm, 10 mm borehole
Ordernumber 38044 EUR 3,80

Brake disc, 100 mm, 10 mm borehole
Ordernumber 38045 EUR 4,20



We produce individual products in stainless steel on your conception.



Picture: rack of stainless steel

GENERAL TERMS AND CONDITIONS

1. GENERAL

- a) The following General Terms and Conditions exclusively form the basis for all deliveries and services. Differing arrangements must be in written form. These General Terms and Conditions apply to all delivery transactions, also to delivery transactions in the future.
- b) All the information concerning the products distributed by us published in product description, brochures or the like, are always subject to confirmation, as far as they are not explicitly bindingly assured. This applies in particular for changes that conduce to technological progress or to maintain the ability to deliver.
- c) Our prices do not include separate accessories, installation or other services - as far as it is not separately stipulated in written form. The order of the customer can be accepted within 14 days by sending the acceptance of order or by delivery and invoice.

2. DELIVERY DATES, DEFAULT, PASSING OF RISK

- a) Binding delivery dates have to be stipulated in written form. They assume the clarification of technical questions as well as self-supply. Should we default delivery because of reasons that we are responsible for, the orderer is authorised to withdraw from the contract according to the present legal regulations, after the orderer has unsuccessfully set an additional respite of a minimum of 2 weeks. Liability for common negligence is excluded. We are authorised for short deliveries. As far as the shipping of the products take place, it occurs of our own choice, whereas the acceptance of shipment and shipping by us only occurs with a special agreement in written form. We are authorised, however not bound, to insure the goods at the expense of the orderer.

3. CONDITIONS OF PAYMENT, DEFAULT OF ACCEPTANCE

- a) Payment of our invoices is, except when otherwise stipulated in written form, due net immediately without any deduction. If the customer is in default of payment, default interest at a rate of 4% higher than the particular bank rate of the Deutsche Bundesbank, but at least 9%, are charged.
- b) Should the customer not accept the sold goods, we can either insist on acceptance or demand 25% of the purchase price as compensation for loss suffered, whereas the purchaser has to proof that no damage or only small damage emerged. Claims of retention are entitled to the customer only as far as his counterclaim is based upon the same contractual relationship. Summation is excluded, unless the counterclaims are legally binding determined or accepted by us.

4. RETENTION OF TITLE

The delivered goods remain the ownership of the signing company until all liabilities are paid, for payment with cheque or exchange until they are encashed. The purchaser is authorised to resell the goods in a regular course of business, but already now he conveys all claims towards his customer or third parties emerging from the resale amounting to the final invoice (including VAT). If the customer acts contrary to contract, in particular if he is in default of payment, we are authorised to take back the sold goods, this is no withdrawal from the contract, unless we would have expressed this explicitly in a written form.

5. PASSING OF RISK

With the delivery of the goods to the customer or his designee, by shipping with delivery to the person in charge of carriage, the risk passes to the customer, no matter who pays the cost of carriage.

6. WARRANTY, LIMITATION OF LIABILITY

- a) As far as a defect of the sold good exists, which we are responsible for, we are authorised of our own choice to the removal of defects or the indemnification. The customer has to reprimand obvious defects within 14 days after the receiving of the goods.
- b) The applying §§377,378 HGB for commercial transactions are not affected. As far as we do not receive a reprimand within 10 workingdays after the arrival of the goods at destination, the goods are classified as approved.
- c) Warranty expires as the customer or unauthorised third parties intervene, repair or try to repair. The assignment of warranty claims are excluded. Replaced parts pass on to our property. We provide for replacement and repair in the same way as we provide for the object of purchase.
- d) If we are not willing or able to deliver compensation, or if the removal of defects fails at least 3 times, the orderer is authorised of his own choice to withdraw from the contract or to demand the abatement of the purchase price.
- e) As far as nothing else results, further requirements of the orderer are excluded, no matter from which cause in law. That is why we are not liable for damages, that are not related to the goods themselves, in particular we are not liable for missed profit or other economic losses of the customer. This release from liability does not apply if the damage has emerged from intention, gross negligence or the absence of an assured attribut, injury of essential duty named in the contract, default of service, impossibility as well as from claims named in §§ 1, 4 Product Liability Act. As far as our liability is excluded or restricted, this does also apply to the personal liability of all our employees, representatives and vicarious agents.

7. PLACE OF FULFILMENT, LEGAL VENUE

Our place of business in Cologne, Germany, is also the legal venue. As far as the acceptance of order does not contain differing information, our place of business is the place of fulfilment for delivery and payment.