



MN1500

Size: AA (LR6)

Alkaline-Manganese Dioxide Battery

Zn/MnO<sub>2</sub>

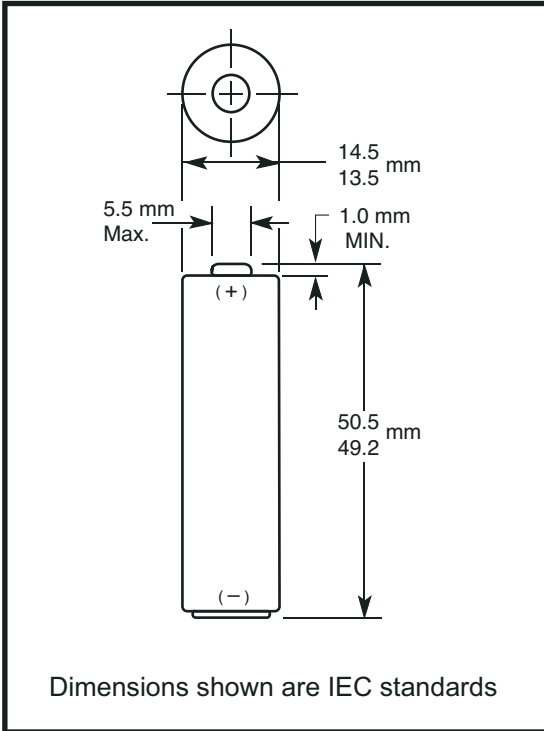

<b>Nominal Voltage:</b>	1.5 V
<b>Operating Voltage</b>	1.6 - 0.75V
<b>Impedance:</b>	120 m-ohm @ 1kHz
<b>Typical Weight:</b>	24 gm (0.8 oz.)
<b>Typical Volume:</b>	8.4 cm <sup>3</sup> (0.5 in. <sup>3</sup> )
<b>Terminals:</b>	Flat
<b>Storage Temperature Range:</b>	-20°C to 35°C
<b>Operating Temperature Range:</b>	-20°C to 54°C (-4°F to 130°F)
<b>ANSI:</b>	15A
<b>IEC:</b>	LR6

TYPICAL DISCHARGE CHARACTERISTICS AT 21°C (70°F)

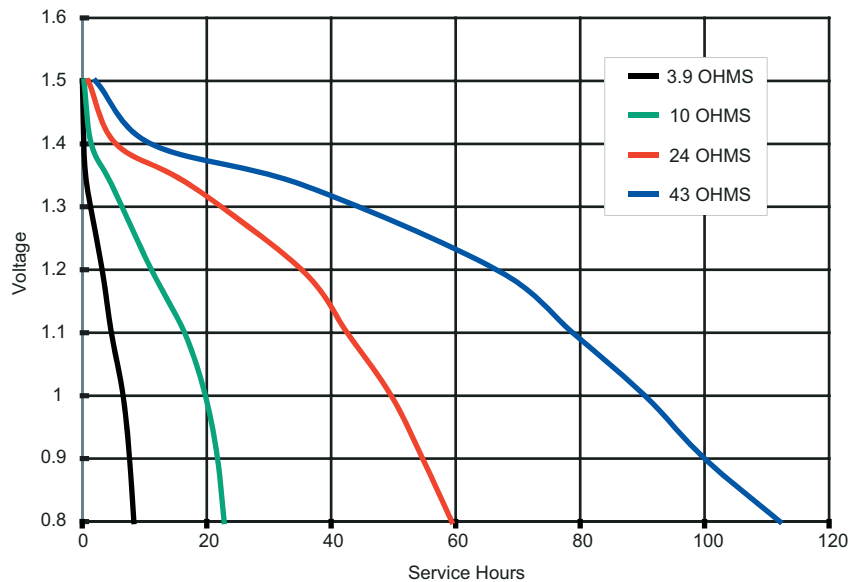

**DURACELL**<sup>®</sup>  
BATTERIES

Berkshire Corporate Park  
Bethel, CT 06801 U.S.A.  
Telephone: Toll-free 1-800-544-5454  
Internet: www.duracell.com

\* Delivered capacity is dependent on the applied load, operating temperature and cut-off voltage. Please refer to the charts and discharge data shown for examples of the energy / service life that the battery will provide for various load conditions.



MN1500

Size: AA (LR6)

Alkaline-Manganese Dioxide Battery

Zn/MnO<sub>2</sub>

TYPICAL CONSTANT CURRENT DISCHARGE CHARACTERISTICS AT 21°C (70°F)

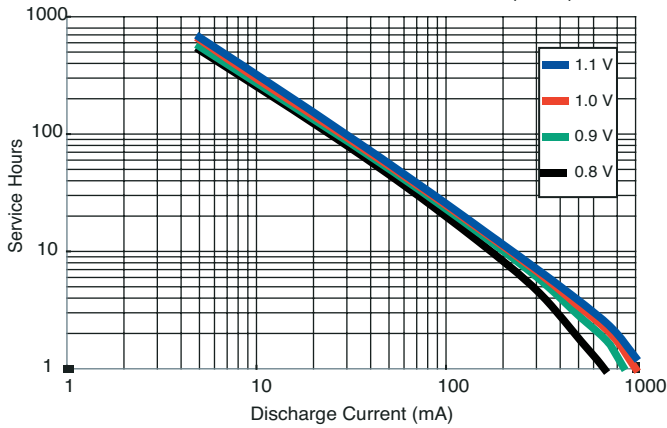

TYPICAL DISCHARGE CHARACTERISTICS AT 21°C (70°F)

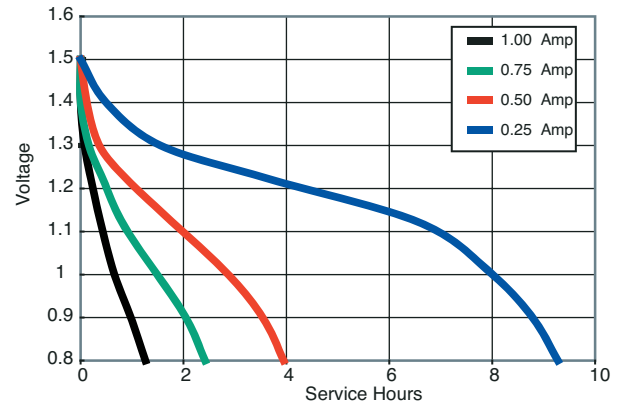

TYPICAL DISCHARGE CHARACTERISTICS AT 21°C (70°F)

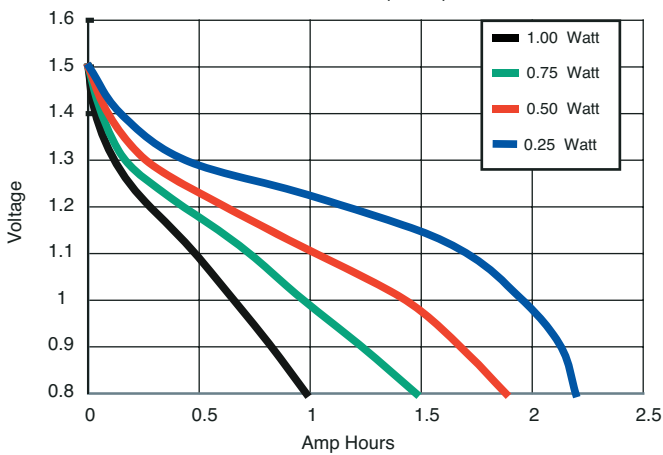

TYPICAL DISCHARGE PERFORMANCE AT 21°C (70°F)

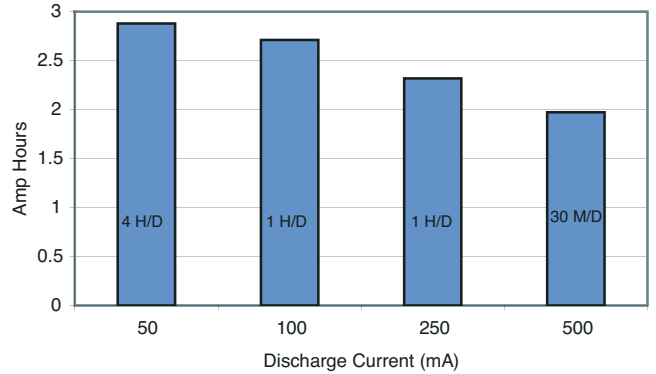

TYPICAL DC RESISTANCE CHARACTERISTICS AT 21°C (70°F)

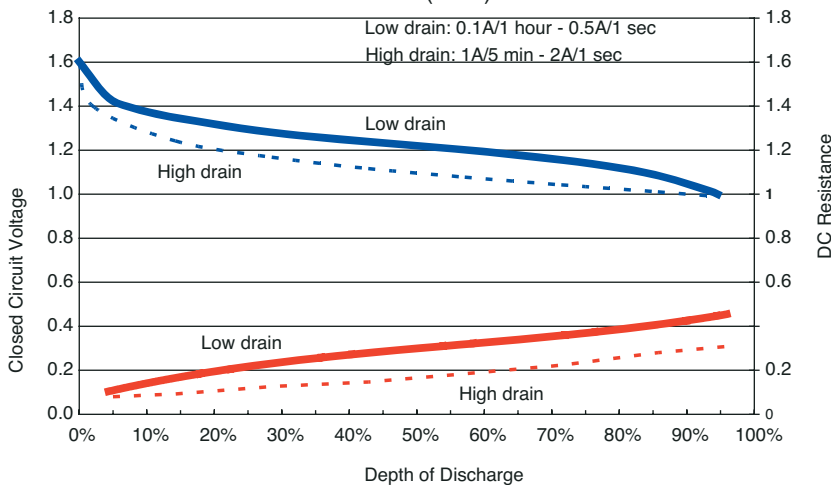

**DURACELL**<sup>®</sup>  
BATTERIES

Berkshire Corporate Park  
Bethel, CT 06801 U.S.A.  
Telephone: Toll-free 1-800-544-5454  
Internet: www.duracell.com

\* Delivered capacity is dependent on the applied load, operating temperature and cut-off voltage. Please refer to the charts and discharge data shown for examples of the energy / service life that the battery will provide for various load conditions.